

# CXPS-E3 Ordering Guide



*Your Power Solutions Partner*

# CXPS-E3 Ordering Guide



- Integrated -48V, 400A power system with front access distribution
- Industry leading power system density
- 400A, 26 distribution positions in 5RU
- Advanced CXC-HP controller with touch screen display for full local control
- High temperature rated design for harsh outdoor applications
- Wide range AC input for flexible worldwide deployment

**Alpha's E3 uses high-density rectifiers, a front access distribution center and the advanced CXC HP controller.**

The E3 is the ideal solution for small to medium-sized 48Vdc applications, providing up to 400 Amps of output current. With universal 19/23" mounting, high temperature operation and high power density, it is the perfect solution for a wide variety of installation scenarios including those in harsh, outdoor environments. The distribution center provides up to 26 load breaker positions, integrated shunt and LVD. All distribution connections and controller I/O contacts are front accessible.

The CXC-HP controller includes a touch screen GUI for simple and convenient local setup. A built-in web server provides alternate setup via local or remote IP access, using a standard internet browser. The E3 can be easily integrated into customer-provided relay racks or enclosures, or can be ordered factory installed into various Alpha relay rack configurations, including systems with pre-wired battery trays.

S.No	Part Number	System Description
1	0919007-001	CXPS-E3, 23", 5RU, -48V, 400A, 2x 2.4kW Rectifier Shelf, CXC-HP, 26 Load Breakers
2	0919006-001	CXPS-E3, 23", 5RU, -48V, 400A, 2x 2.4kW Rectifier Shelf, CXC-HP, 21 Load Breakers, 5 Battery Breakers, e/w LVBD
3	0919007-002	CXPS-E3, 19", 5RU, -48V, 400A, 2x 2.4kW Rectifier Shelf, CXC-HP, 21 Load Breakers
4	0919006-002	CXPS-E3, 19", 5RU, -48V, 400A, 2x 2.4kW Rectifier Shelf, CXC-HP, 16 Load Breakers, 5 Battery Breakers, e/w LVBD

**Alpha Technologies Ltd.**

Canada: Burnaby, British Columbia T: 604.436.5900 F: 604.436.1233  
 United States: Bellingham, Washington T: 360.647.2360 F: 360.671.4936

For more information visit [www.alpha.ca](http://www.alpha.ca)

#0470209-00 Rev E (03/2018)

Alpha Technologies reserves the right to make changes to the products and information contained in this document without notice. Copyright © 2018 Alpha Technologies. All Rights Reserved. Alpha® is a registered trademark of Alpha Technologies. member of The Alpha Group™ is a trademark of Alpha Technologies.

member of The  Group™

# HOW TO BUILD AN E3 POWER SYSTEM

## STEP 1: Pick Seismic Rack (Integrated in Systems)

Part Number	Seismic Rack Option
0300163-001	23", 7'0" Height, 2500lb, Welded Seismic Rack
0300063-003	23", 3'6" Height, 500lb, Bolted Seismic Rack
0300047-001	23", 7'0" Height, 1500lb, Bolted Seismic Rack
0300047-002	23", 7'0" Height, 1000lb, Bolted Seismic Rack
0300047-003	23", 7'0" Height, 500lb, Bolted Seismic Rack
0300064-001	23", 7'6" Height, 1500lb, Bolted Seismic Rack
0300065-001	23", 8'0" Height, 1500lb, Bolted Seismic Rack
0300066-001	23", 9'0" Height, 1500lb, Bolted Seismic Rack
0300062-001	19", 7'0" Height, 1500lb, Bolted Seismic Rack
0300062-002	19", 7'0" Height, 1000lb, Bolted Seismic Rack
0300062-003	19", 7'0" Height, 500lb, Bolted Seismic Rack

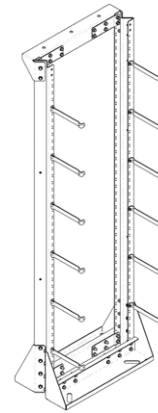

## STEP 2: Pick E3 Power System (Integrated in Systems)

Part Number	Power System Option
0919007-001	CXPS-E3, 23", 5RU, -48V, 400A, 2x 2.4kW Rectifier Shelf, CXC-HP, 26 Load Breakers
0919006-001	CXPS-E3, 23", 5RU, -48V, 400A, 2x 2.4kW Rectifier Shelf, CXC-HP, 21 Load Breakers, 5 Battery Breakers, e/w LVBD
0250030-015	CXPS-E3, 19", 5RU, -48V, 400A, 2x 2.4kW Rectifier Shelf, CXC-HP, 21 Load Breakers
0250030-014	CXPS-E3, 19", 5RU, -48V, 400A, 2x 2.4kW Rectifier Shelf, CXC-HP, 16 Load Breakers, 5 Battery Breakers, e/w LVBD

## STEP 3: Pick Battery Trays (Integrated in Systems)

Part Number	System Integration Items
0300061-003 (0300061-503)	23", Seismic Battery Tray (23", Seismic Battery Tray, Field Service Kit)
0300077-002	19", Seismic Battery Tray
0380128-001 (0380128-501)	19/23", Breaker Housing Kit (19/23", Breaker Housing Kit, Field Service Kit)
0250030-550	Battery Cable Landing Bus Bar Kit

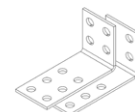
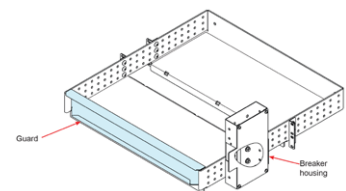

Alpha Technologies Ltd.

Canada: Burnaby, British Columbia T: 604.436.5900 F: 604.436.1233  
 United States: Bellingham, Washington T: 360.647.2360 F: 360.671.4936

For more information visit [www.alpha.ca](http://www.alpha.ca)

#0470209-00 Rev E (03/2018)

Alpha Technologies reserves the right to make changes to the products and information contained in this document without notice.  
 Copyright © 2018 Alpha Technologies. All Rights Reserved. Alpha® is a registered trademark of Alpha Technologies.  
 member of The Alpha Group™ is a trademark of Alpha Technologies.

member of The  Group™

#### STEP 4: Pick Battery Breakers (Integrated in Systems)

Part Number	Plug-in Battery Breakers (Installed into E3)
470-347-10	CB, 1P, 100A, 80Vdc, 5/16" Bullet, Series-trip
4700153*	CB, 2P, 200A, 80Vdc, 5/16" Bullet, Series-trip
4700235**	CB, 3P, 300A, 80Vdc, 5/16" Bullet, Series-trip
Part Number	Bolt-in Battery Breakers (Installed into breaker housing)
470-054-10	CB, 1P, 100A, 65Vdc, 1/4-20 Bolt-In, Series-trip
470-228-10	CB, 1P, 250A, 125Vdc, 7/16" Bolt-In

\* 2 Pole Breaker Adaptor Kit is required      \*\* 3 Pole Breaker Adaptor Kit is required

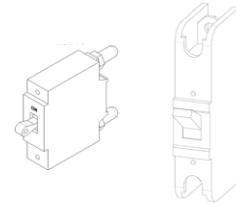

#### STEP 5: Pick Mid-Point Monitoring System (Integrated in Systems)

Part Number	System Integration Items
018-546-20-150	23", 1RU, SD08 BFDM Shelf, 4x Blank Modules
018-546-20-157	19", 1RU, SD08 BFDM Shelf, 3x Blank Modules
747-109-20-140	SD08 Mid-Point Battery Monitor Module

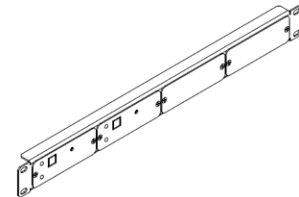

#### STEP 6: Pick Temperature Probes (Integrated in Systems)

Part Number	Temperature Probes	Part Number	Temperature Probes
747-028-20-071	Temp Snsr, 1/4" Lug, 6ft Cable Assy	747-082-20-071	Temp Snsr, 3/8" Lug, 6ft Cable, Assy
747-028-20-072	Temp Snsr, 1/4" Lug, 12ft Cable Assy	747-082-20-072	Temp Snsr, 3/8" Lug, 12ft Cable, Assy
747-028-20-073	Temp Snsr, 1/4" Lug, 24ft Cable Assy	747-082-20-073	Temp Snsr, 3/8" Lug, 24ft Cable, Assy
747-028-20-080	Temp Snsr, 1/4" Lug, 50ft Cable Assy	747-082-20-080	Temp Snsr, 3/8" Lug, 50ft Cable, Assy
747-028-20-081	Temp Snsr, 1/4" Lug, 100ft, Cable Assy	747-082-20-081	Temp Snsr, 3/8" Lug, 100ft Cable, Assy

Alpha Technologies Ltd.

For more information visit [www.alpha.ca](http://www.alpha.ca)

Canada: Burnaby, British Columbia T: 604.436.5900 F: 604.436.1233  
 United States: Bellingham, Washington T: 360.647.2360 F: 360.671.4936

#0470209-00 Rev E (03/2018)

Alpha Technologies reserves the right to make changes to the products and information contained in this document without notice.  
 Copyright © 2018 Alpha Technologies. All Rights Reserved. Alpha® is a registered trademark of Alpha Technologies.  
 member of The Alpha Group™ is a trademark of Alpha Technologies.

member of The  Group™

### STEP 7: Pick Seismic Rack Accessories (Shipped Loose)

Part Number	Seismic Rack Accessories
0380042-021	Seismic Anchor and Washer Kit
0380063-001	23", Bolted Seismic Rack Insulation Pad and Bushing Kit
0380108-001	19", Bolted Seismic Rack Insulation Pad and Bushing Kit
0380195-001	23", Welded Seismic Rack Insulation Pad and Bushing Kit

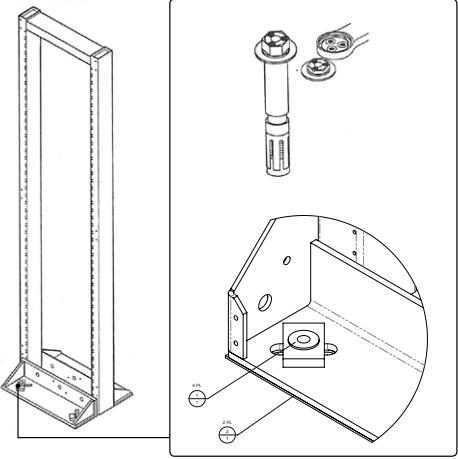

### STEP 8: Pick Rectifiers (Shipped Loose)

Part Number	Rectifiers
0100003-001	48V, 2.4kW Rectifier
7400424-001	2.4kW Rectifier Blank

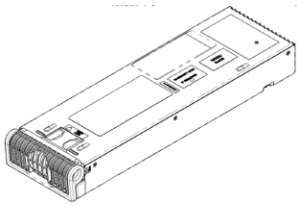

## STEP 9: Pick Load Breakers (Shipped Loose)

Part Number	Load Breakers
470-300-10	CB, 1P, 1A, 80Vdc, 5/16" Bullet, Mid-trip
470-301-10	CB, 1P, 3A, 80Vdc, 5/16" Bullet, Mid-trip
470-302-10	CB, 1P, 5A, 80Vdc, 5/16" Bullet, Mid-trip
470-303-10	CB, 1P, 10A, 80Vdc, 5/16" Bullet, Mid-trip
470-304-10	CB, 1P, 15A, 80Vdc, 5/16" Bullet, Mid-trip
470-305-10	CB, 1P, 20A, 80Vdc, 5/16" Bullet, Mid-trip
470-306-10	CB, 1P, 25A, 80Vdc, 5/16" Bullet, Mid-trip
470-307-10	CB, 1P, 30A, 80Vdc, 5/16" Bullet, Mid-trip
470-308-10	CB, 1P, 35A, 80Vdc, 5/16" Bullet, Mid-trip
470-309-10	CB, 1P, 40A, 80Vdc, 5/16" Bullet, Mid-trip
470-310-10	CB, 1P, 45A, 80Vdc, 5/16" Bullet, Mid-trip
470-311-10	CB, 1P, 50A, 80Vdc, 5/16" Bullet, Mid-trip
470-312-10	CB, 1P, 60A, 80Vdc, 5/16" Bullet, Mid-trip
470-313-10	CB, 1P, 70A, 80Vdc, 5/16" Bullet, Mid-trip
470-314-10	CB, 1P, 80A, 80Vdc, 5/16" Bullet, Mid-trip
470-315-10	CB, 1P, 90A, 80Vdc, 5/16" Bullet, Mid-trip
470-316-10	CB, 1P, 100A, 80Vdc, 5/16" Bullet, Mid-trip
470-317-10*	CB, 2P, 110A, 80Vdc, 5/16" Bullet, Mid-trip
470-318-10*	CB, 2P, 125A, 80Vdc, 5/16" Bullet, Mid-trip
470-319-10*	CB, 2P, 150A, 80Vdc, 5/16" Bullet, Mid-trip
4700234*	CB, 2P, 175A, 80Vdc, 5/16" Bullet, Mid-trip
4700154*	CB, 2P, 200A, 80Vdc, 5/16" Bullet, Mid-trip
470-357-10**	CB, 3P, 225A, 80Vdc, 5/16" Bullet, Mid-trip
470-342-10**	CB, 3P, 250A, 80Vdc, 5/16" Bullet, Mid-trip
4700149**	CB, 3P, 300A, 80Vdc, 5/16" Bullet, Mid-trip

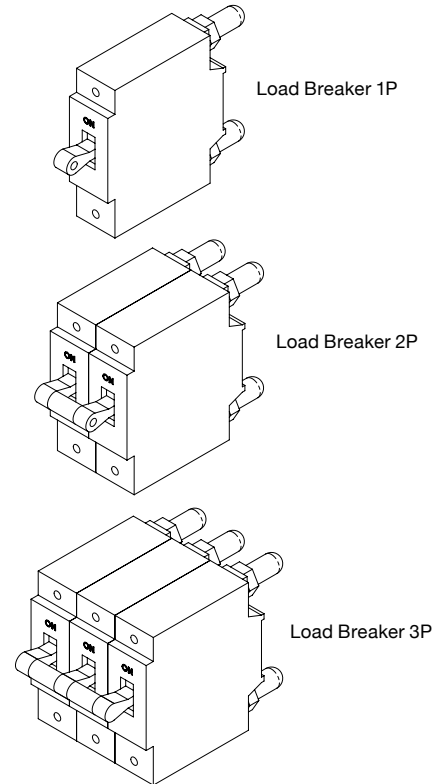

\* 2 Pole Breaker Adaptor Kit is required      \*\* 3 Pole Breaker Adaptor Kit is required

### Alpha Technologies Ltd.

Canada: Burnaby, British Columbia T: 604.436.5900 F: 604.436.1233  
 United States: Bellingham, Washington T: 360.647.2360 F: 360.671.4936

For more information visit [www.alpha.ca](http://www.alpha.ca)

#0470209-00 Rev E (03/2018)

Alpha Technologies reserves the right to make changes to the products and information contained in this document without notice.  
 Copyright © 2018 Alpha Technologies. All Rights Reserved. Alpha® is a registered trademark of Alpha Technologies.  
 member of The Alpha Group™ is a trademark of Alpha Technologies.

member of The  Group™

## STEP 10: Pick Breaker Adaptor Kit

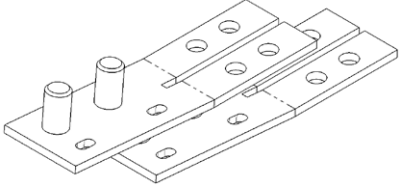
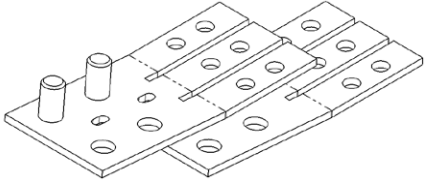
Part Number	Breaker Adaptor Kit	
0370298-001	CXDM-E2/E3, 2 Pole Breaker Adaptor Kit	
0370299-001	CXDM-E2/E3, 3 Pole Breaker Adaptor Kit	

## STEP 11: Pick TPS Fuses (Shipped Loose)

Part Number	TPS Fuses
460-217-10	TPS/TLS Fuse, 5A, 170Vdc
460-218-10	TPS/TLS Fuse, 6A, 170Vdc
460-219-10	TPS/TLS Fuse, 10A, 170Vdc
460-220-10	TPS/TLS Fuse, 15A, 170Vdc
460-221-10	TPS/TLS Fuse, 20A, 170Vdc
460-222-10	TPS/TLS Fuse, 25A, 170Vdc
460-223-10	TPS/TLS Fuse, 30A, 170Vdc
460-224-10	TPS/TLS Fuse, 40A, 170Vdc
460-225-10	TPS/TLS Fuse, 50A, 170Vdc
460-226-10	TPS/TLS Fuse, 60A, 170Vdc
460-227-10	TPS/TLS Fuse, 70A, 170Vdc
460-229-10	TPS/TLS Fuse, 90A, 170Vdc
460-230-10	TPS/TLS Fuse, 100A, 170Vdc
4600056	TPS/TLS Fuse, 110A, 170Vdc
4600057	TPS/TLS Fuse, 125A, 170Vdc
520-059-10	TFD Fuse Holder

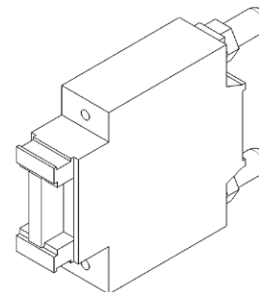

Alpha Technologies Ltd.

For more information visit [www.alpha.ca](http://www.alpha.ca)

Canada: Burnaby, British Columbia T: 604.436.5900 F: 604.436.1233  
 United States: Bellingham, Washington T: 360.647.2360 F: 360.671.4936

#0470209-00 Rev E (03/2018)

Alpha Technologies reserves the right to make changes to the products and information contained in this document without notice.  
 Copyright © 2018 Alpha Technologies. All Rights Reserved. Alpha® is a registered trademark of Alpha Technologies.  
 member of The Alpha Group™ is a trademark of Alpha Technologies.

member of The  Group™